



# USER MANUAL

---

## **Elo Touch Solutions** 15" All-in-one Touch computer



Copyright © 2019 Elo Touch Solutions, Inc. All Rights Reserved.

No part of this publication may be reproduced, transmitted, transcribed, stored in a retrieval system, or translated into any language or computer language, in any form or by any means, including, but not limited to, electronic, magnetic, optical, chemical, manual, or otherwise without prior written permission of Elo Touch Solutions, Inc.

#### Disclaimer

The information in this document is subject to change without notice. Elo Touch Solutions, Inc. and its Affiliates (collectively "Elo") makes no representations or warranties with respect to the contents herein, and specifically disclaims any implied warranties of merchantability or fitness for a particular purpose. Elo reserves the right to revise this publication and to make changes from time to time in the content hereof without obligation of Elo to notify any person of such revisions or changes.

#### Trademark Acknowledgments

Elo, Elo (logo), Elo Touch, Elo Touch Solutions, TouchPro are trademarks of Elo and its Affiliates. Windows is a trademark of Microsoft Corporation.

# Table of Contents

Section 1: Introduction.....	3
Section 2: Installation .....	10
Section 3: Operation.....	12
Section 4: Options and Upgrades .....	21
Section 5: Technical Support .....	23
Section 6: Safety & Maintenance .....	24
Section 7: Regulatory Information.....	27
Section 8: Warranty Information.....	36

# Section 1: Introduction

## Product Description

The versatile EloPOS System combines modern aesthetics, modular flexibility and commercial-grade reliability. Purpose-built for point of sale, EloPOS offers a 15.6-inch touchscreen display with 1366 x 768 resolution, a choice of Intel's 8th generation Gemini Lake Celeron processors or the i3 and i5 Core Coffee Lake processors. All models include TPM 2.0 and i5 models support VPRO for maximum system security and manageability. All models utilize one of two connectivity hubs. One is an integrated expansion hub stand and a rear mounted hub providing a wide array of mounting options. These hubs provide the flexibility need for peripheral you need for any application- whether a customer facing display, payment reader, printer, cash drawer, barcode scanner or scale, EloPOS has it covered. From traditional POS to self-service applications. EloPOS delivers the durability needed to survive continuous public use and is backed by Elo's standard 3-year warranty.

## Precautions

Follow all warnings, precautions and maintenance tips as recommended in this user manual to maximize the life of your unit and prevent risks to user safety. See Chapter 6 for more information on safety.

This manual contains information that is important for the proper setup and maintenance of the EloPOS All-in-one touch computers. Before setting up and powering on your unit, please read through this manual in detail seriously and carefully.

# EloPOS Layout

## EloPOS 15" Models

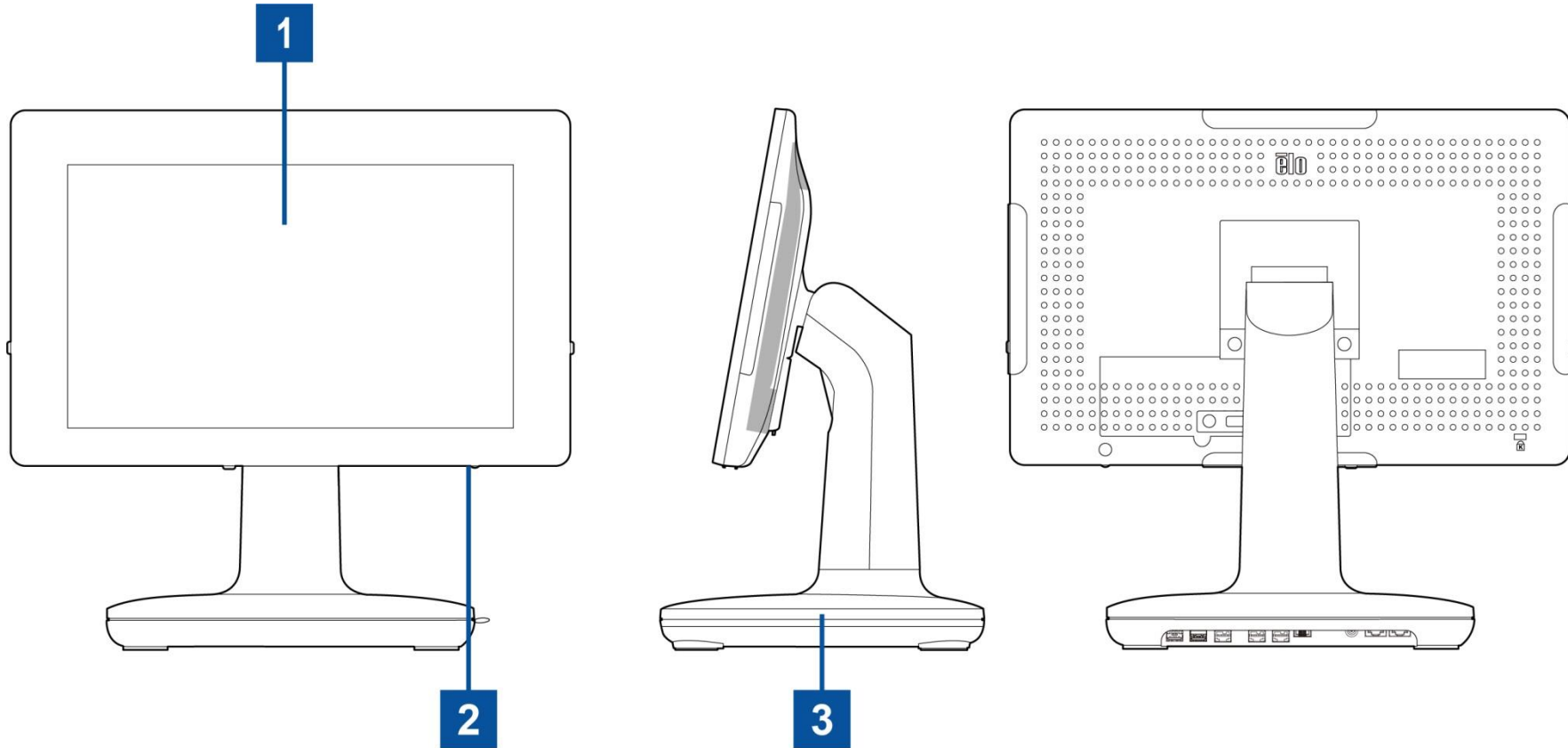

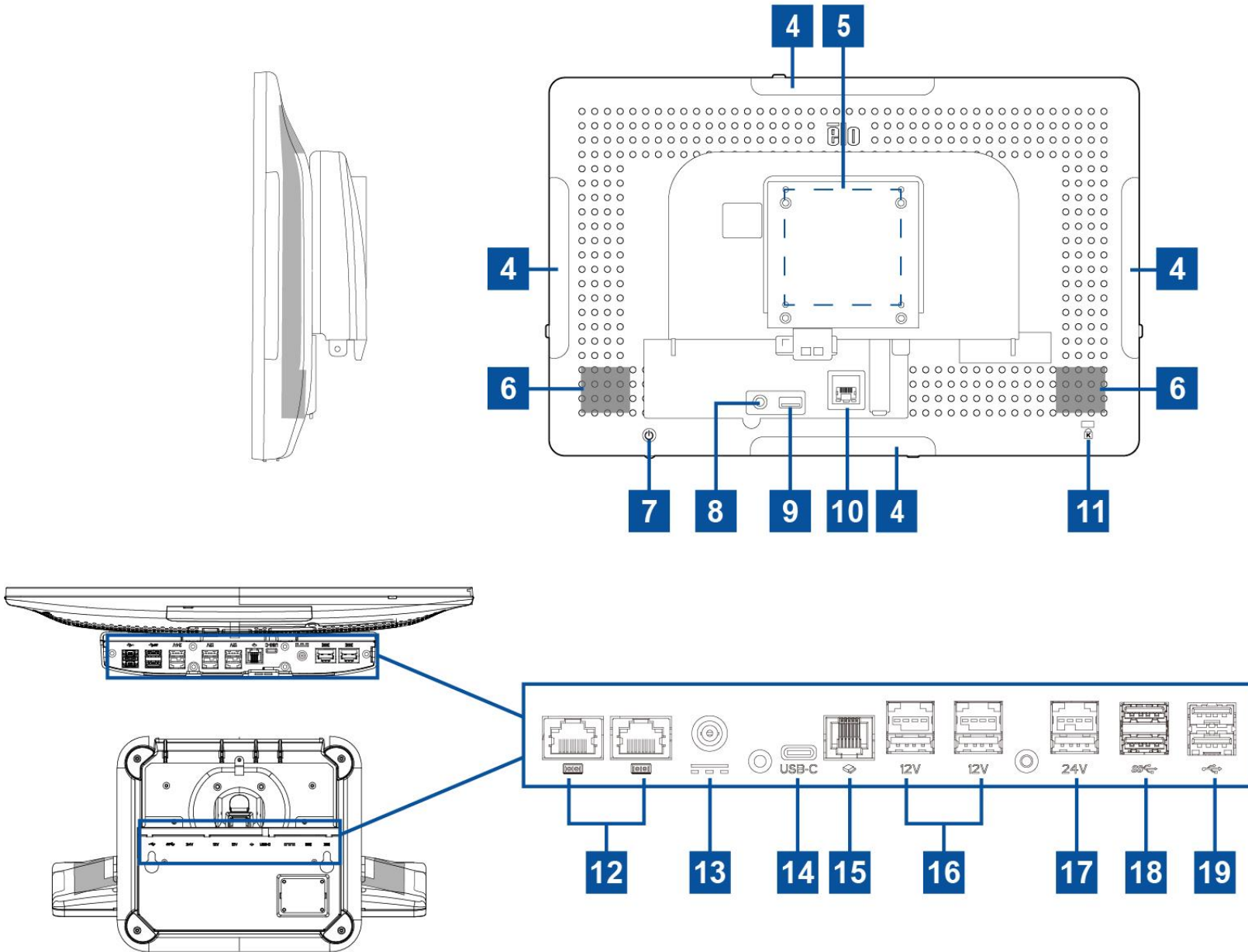

1	Display with Touch	11	Kensington Lock
2	Power Indicator LED	12	Serial Port (COM1/RJ-45)/ Serial Port (COM2/RJ-45)
3	Stand Module	13	Power Connector (DC-IN)
4	Edge Micro USB Port for Elo Peripherals	14	USB Type C Port
5	Wall Mount/Arm Screw Hole	15	Cash Drawer Port (A/B)
6	Speaker	16	+12 Volt Powered USB Port
7	Power Button	17	+24 Volt Powered USB Port
8	Headset	18	USB 3.0 Port
9	USB 3.0 Port	19	USB 2.0 Port
10	Ethernet LAN Port		

## 1. Display with Touch

The model is available with the following touch technologies.

- TouchPro, zero-bezel projective capacitive (PCAP)

## 2. Power Indicator LED

The power indicator LED shows the state of the touch computer. See Section 3 for more details.

## 3. Stand Module

The stand module is a robust design supporting Elo All-in-one touch computers.

## 4. Edge Micro USB Port (Accessory kit - connections)

The EloPOS includes four edge USB ports on the display for mounting optional peripherals. The peripherals can be mounted and fixed at the edge to meet many IO peripheral requirements.

## 5. VESA Mount

A four-hole 75x75mm for the rest size mounting pattern for M4 screws is provided on the rear of the monitor. The VESA FDMI-compliant counting is coded: VESA MIS-D, C

## 6. Speaker

Two, integrated, 2 watt speakers provide audio output for playback.

## 7. Power Button

Press the power button to turn on/off the touch computer system.

## 8. Headset

The audio port is designed for headset and microphone connectivity.

## 9. USB 3.0 Port

A standard Super Speed USB 3.0 port is available on the rear side of the touch computer system.

## 10. Ethernet LAN Port

The EloPOS Ethernet LAN Port provides up to 1 Gbps speed capability for networking.

## 11. Kensington Lock

Kensington Lock is a standard anti-theft mechanism to secure the desktop to the desired mounting location. The Kensington cable lock is not included.

## 12. Serial Port (COM1/RJ-45)/Serial Port (COM2/RJ-45)

The serial port is a native RS-232 specification for RJ-45 interface connection.

## 13. Power Connector (DC-IN)

To power up the touch computer, plug the DC connector of the AC/DC power adaptor kit into the power connection on the device.

**Note:** When you need to detach the DC plug from the stand module, grip it as the picture shown below and remove it carefully.

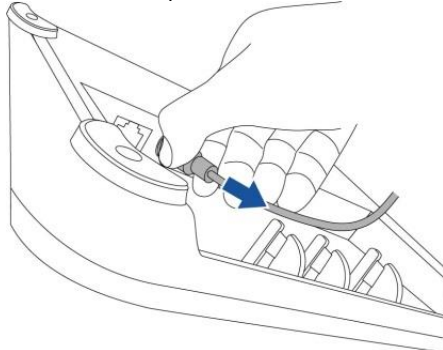



## 14. USB Type-C Port

The USB Type-C port allows connection to other type-C compatible devices.

## 15. Cash Drawer Port (A/B)

The main cash drawer port is a RJ-12 interface design and provides switchable operation at +12VOLTS and +24VOLTS. The default setting is at +24 Volts and the settings are adjustable from the bottom of the stand module, or the back of monitor.

### a. Cash Drawer Port Pin assignment

Pin#	Signal Name	Pin#	Signal Name
1	GND	2	CD1-
3	CD1 Sense	4	CD Drive (+24/12V)
5	CD2-	6	Reserve

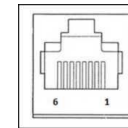

### b. Switching between the +12VOLTS and +24VOLTS

- i. Remove the cover from the bottom of the stand module, or the back of the touch computer to reveal the switch.
- ii. Slide the switch between 24V or 12V for the cash drawer power.

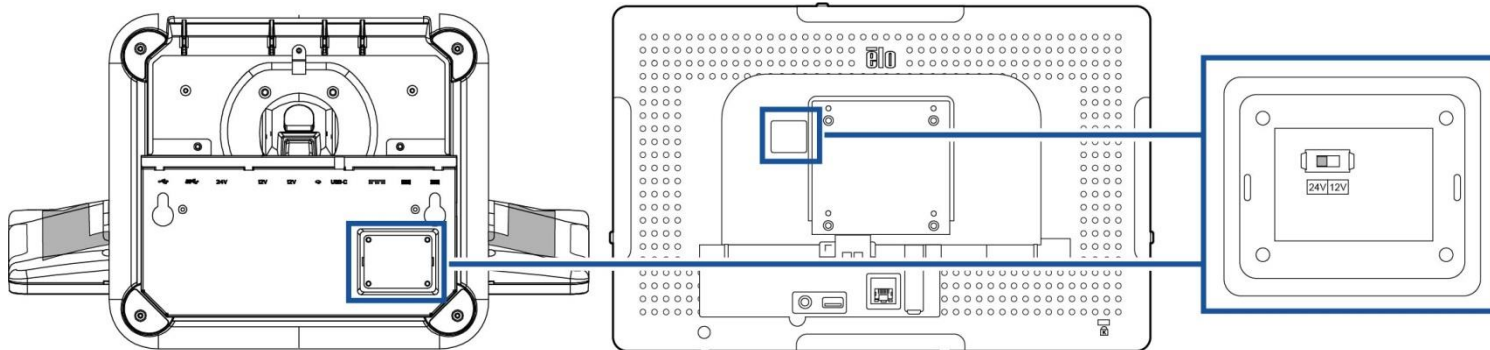

## 16. +12 Volt Powered USB Port

The maximum power rating of the +12 Volt Powered USB would be limited to 12 Volts at 1.5 Amps.

## 17. +24 Volt Powered USB Port

The +24 Volt Powered USB Port spec is design for all EloPOS models. The maximum power rating of the +24 Volt Power USB is 24 Volt at 2.3 Amps. In special circumstance, please use an external power adapter for your 24V peripheral (DO NOT USE on board 24V Powered USB port) when both your system is running 100% loading and all I/O ports except 24V Powered USB port are connected for the maximum power load of each port.

Please ensure your overall peripheral power consumption does not exceed the following (assuming system is running at max power consumption which is not common for POS applications):

- a. Not exceed 156W for E2 models.
- b. Not exceed 115W for E3 models.
- c. Not exceed 106W for E5 models.

## **18. USB 3.0 Port**

Two standard Super Speed USB 3.0 ports are available on the input/output panel of the touch computer system.

## **19. USB 2.0 Port**

Two USB 2.0 ports are available on the input/output panel of the touch computer system

# Section 2: Installation

## Unpacking the Touch Computer

Open the carton and verify that the following items are present:

- EloPOS Touchcomputer
- Power Cable US/Canada
- Power Cable Europe
- +24 Volt Power Adaptor
- RJ45 to RS232 Serial Cable
- Quick Install Guide
- Security Cover & Screws
- Cable Management kit

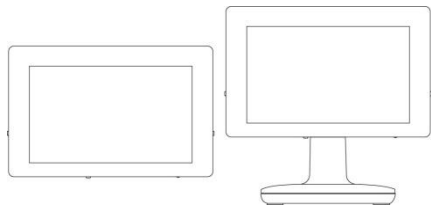

EloPOS Touchcomputer



Power Cable US/Canada



Power Cable Europe



+24 Volt Power Adaptor

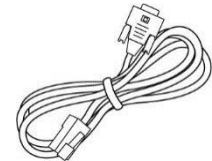

RJ45 to RS232 Serial Cable



Quick Install Guide

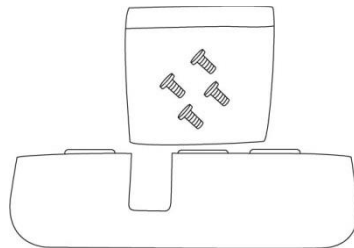

Security Cover & Screws

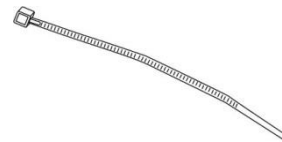

Cable Management Kit

## Adjusting the Display to a Suitable Position

The touch computer provides tilt adjustment to the monitor for different deployment scenarios. The tilt adjustment is shown below.

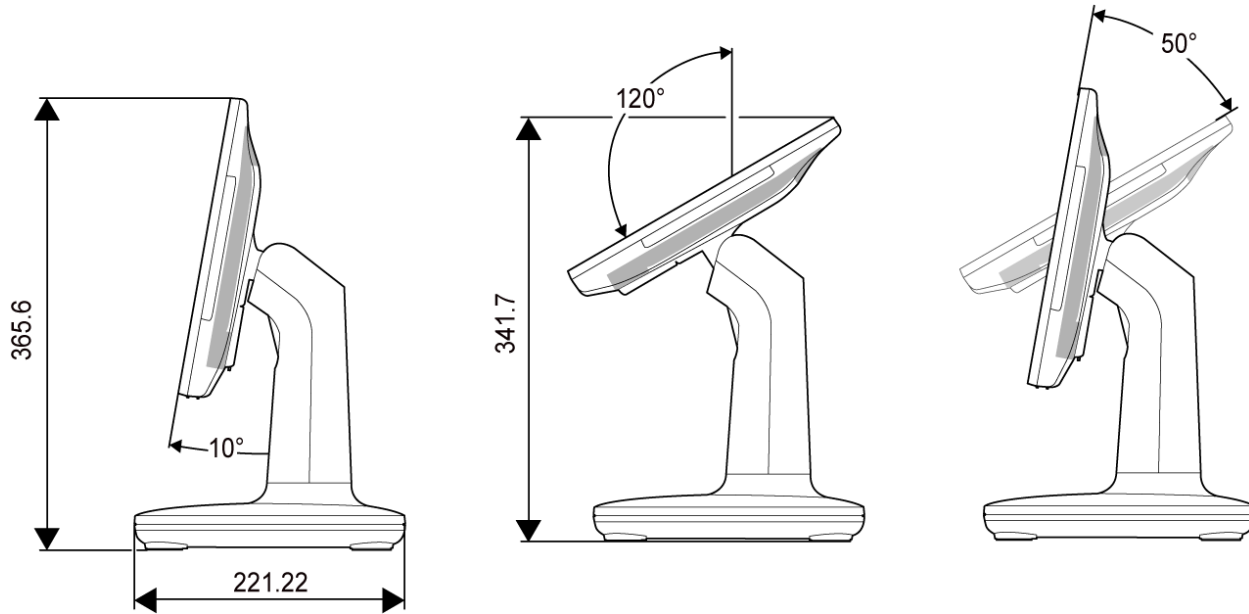

When the display is set to portrait mode, ensure you install your display head in the drawing shown below (Power key is in the bottom side).

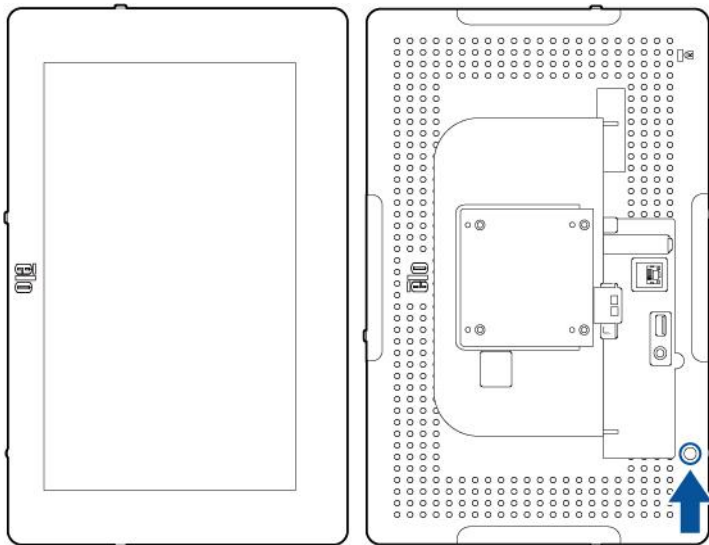

# Section 3: Operation

## General Information

This section describes unique features of the Elo all-in-one Touch computer.

### Power LED

The EloPOS has a Power LED indicating the state of the touch computer. The table below shows LED state and corresponding color.

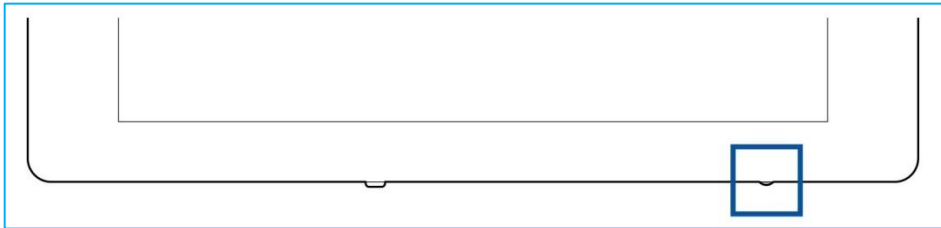

Touch Computer Status	LED Status
AC off	Off
Off mode	Red
Sleep mode	Orange
On	Green

Touching the screen will bring the system out of SLEEP mode (similar to moving the mouse or pressing a keyboard key).

### Ethernet LAN LED

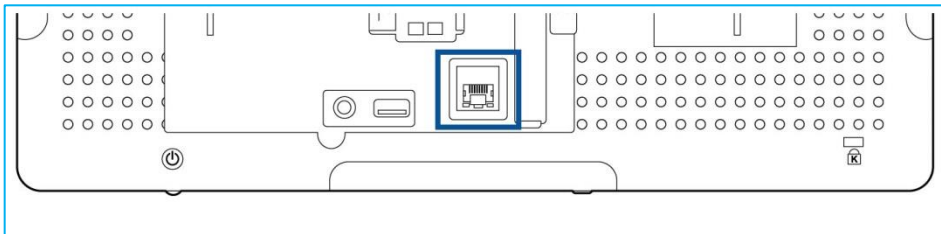

LAN Speed Status	LAN LED Status
10 Mbps	No Color
100 Mbps	Orange Color
1 Gbps	Green Color

Activity Status	ACT LED Status
No Link	No Color
Linked	Solid (Green Color)
Data Activity	Blinking (Green Color)

## Touch

Your touchscreen display is factory-calibrated and does not need any additional manual calibration.

## Setting Up the Operating System

If configured with an operating system, the initial setup of the operating system takes approximately 5-10 minutes. Additional time may be needed depending on the touch computer hardware configurations and connected devices.

To set up the Microsoft® Windows® Operating System for the touch computer, turn on the touch computer by pressing the power button, and then follow the on-screen instructions.

Elo has taken time to ensure all drivers are correct and loaded for your Windows operating system. If you decide to create your own image to reproduce on many systems, be sure to start with the Elo image or Elo driver packs under support. Or contact our support team for help.

## Creating the Recovery Flash Drive

All Windows 10 touch computers come with the built-in Elo Restore Utility on the Windows Desktop. The utility is able to create a recovery flash drive based on the operating system you purchased. **Please create your recovery flash drive immediately.** In the event the HDD/SSD recovery partition is accidentally deleted or becomes inaccessible, you will need to use the recovery flash drive to recover your system.

The following procedures demonstrate how to use the utility to create a recovery flash drive.

1. Right-click the EloRestoreUtility icon on the Desktop and select **"Run as administrator"**.
2. Click **"Start"** button to begin the process.

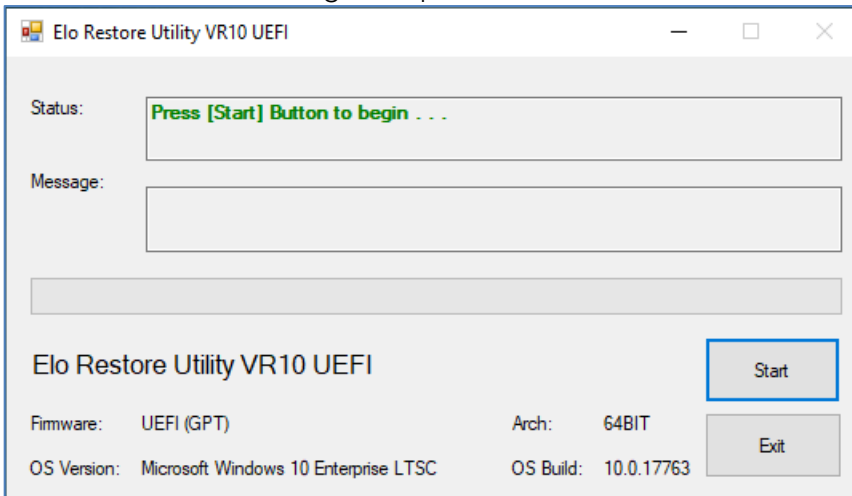

3. Once completed, you shall see a pop-up window to ask to insert a blank flash drive to any of available USB ports on your system.

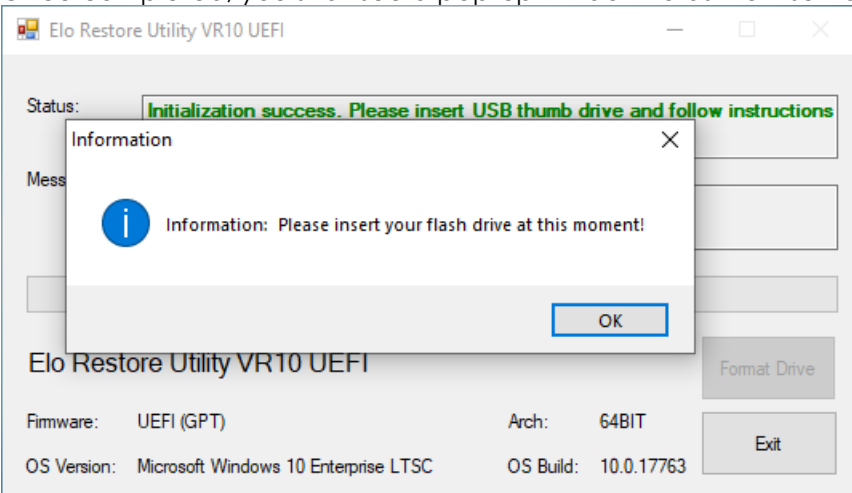

4. After the flash drive is inserted, you shall see a window as shown below. Click **“Format Drive”** to continue the process. **PLEASE NOTE THAT ALL DATA WILL BE LOST DURING THIS PROCESS.**

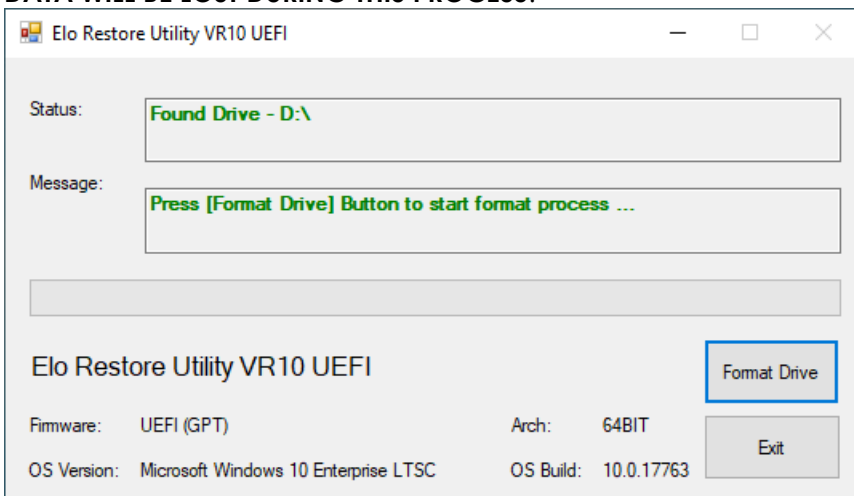

5. Click **“Create Restore Media”** to proceed. This step will take 10-20 minutes depending on your system configurations and flash drive performance.

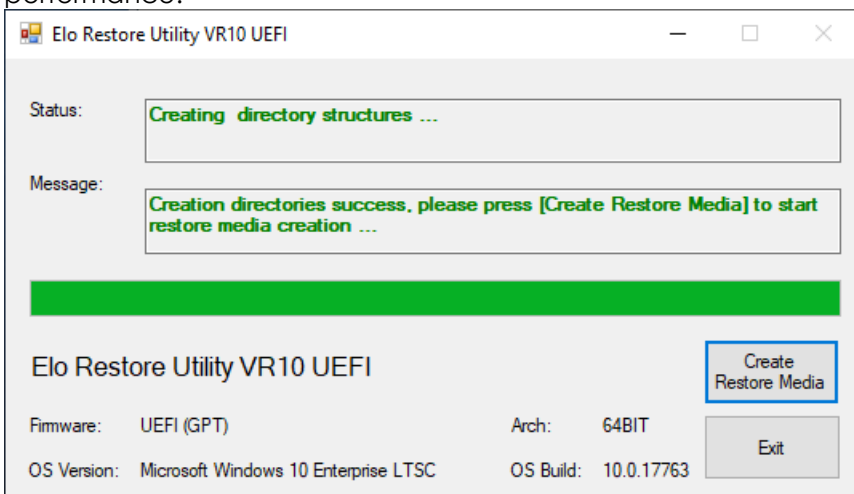



6. Once the message shows "**Creation Restore Media success...**", please remove the flash drive and click "**Exit**" to exit the program.

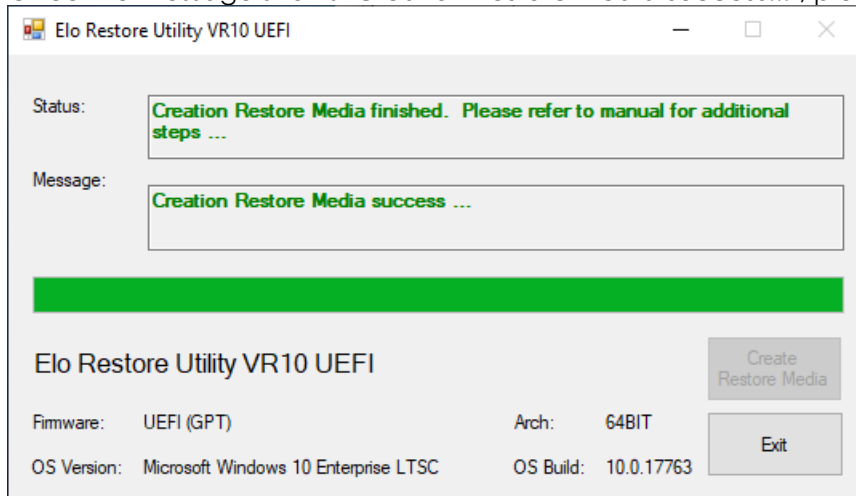

7. In case the system is crashed and you have to use the recovery flash drive, reboot the system and press **F11** several times to enter **DeviceBoot Menu**. Then, choose "**boot from flash drive**".
8. When the following UI is presented, click "**Install Recovery Solution**" button.

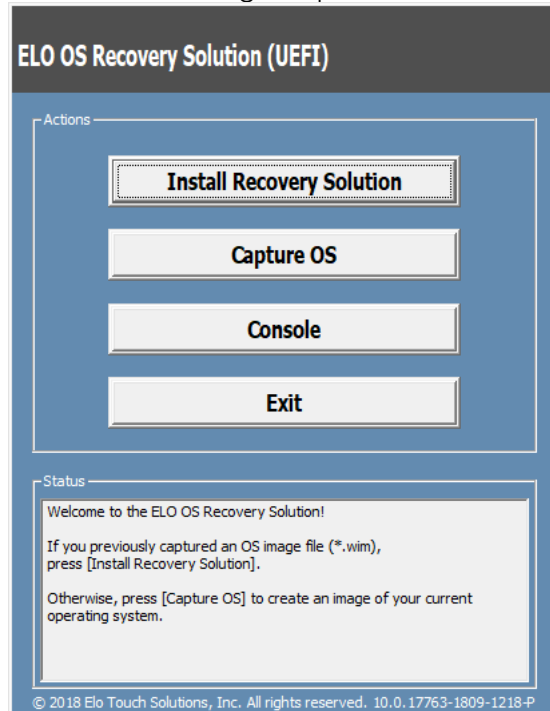

9. Follow the on-screen instructions to complete the installation process and then exit the program.

**Note: All data is deleted during the recovery process. The user must back up files when necessary. Elo Touch Solutions does not accept liability for lost data or software.**

**Note: The end user must adhere to Microsoft's Licensing Agreement.**

## Recovering the Operating System

If for any reason the touch computer's operating system needs to be recovered to FACTORY SETTINGS, you can recover your system by following the procedures below. **PLEASE NOTE THAT ALL CUSTOMER SETTINGS AND DATA WILL BE LOST DURING THIS PROCESS.** Please be sure to completely backup all of your data, settings, and customer-installed software before proceeding.

1. Power off your system completely.
2. Power on your system.
3. When the following screen appears, tap to select "**UEFI – Recover Operating System**".

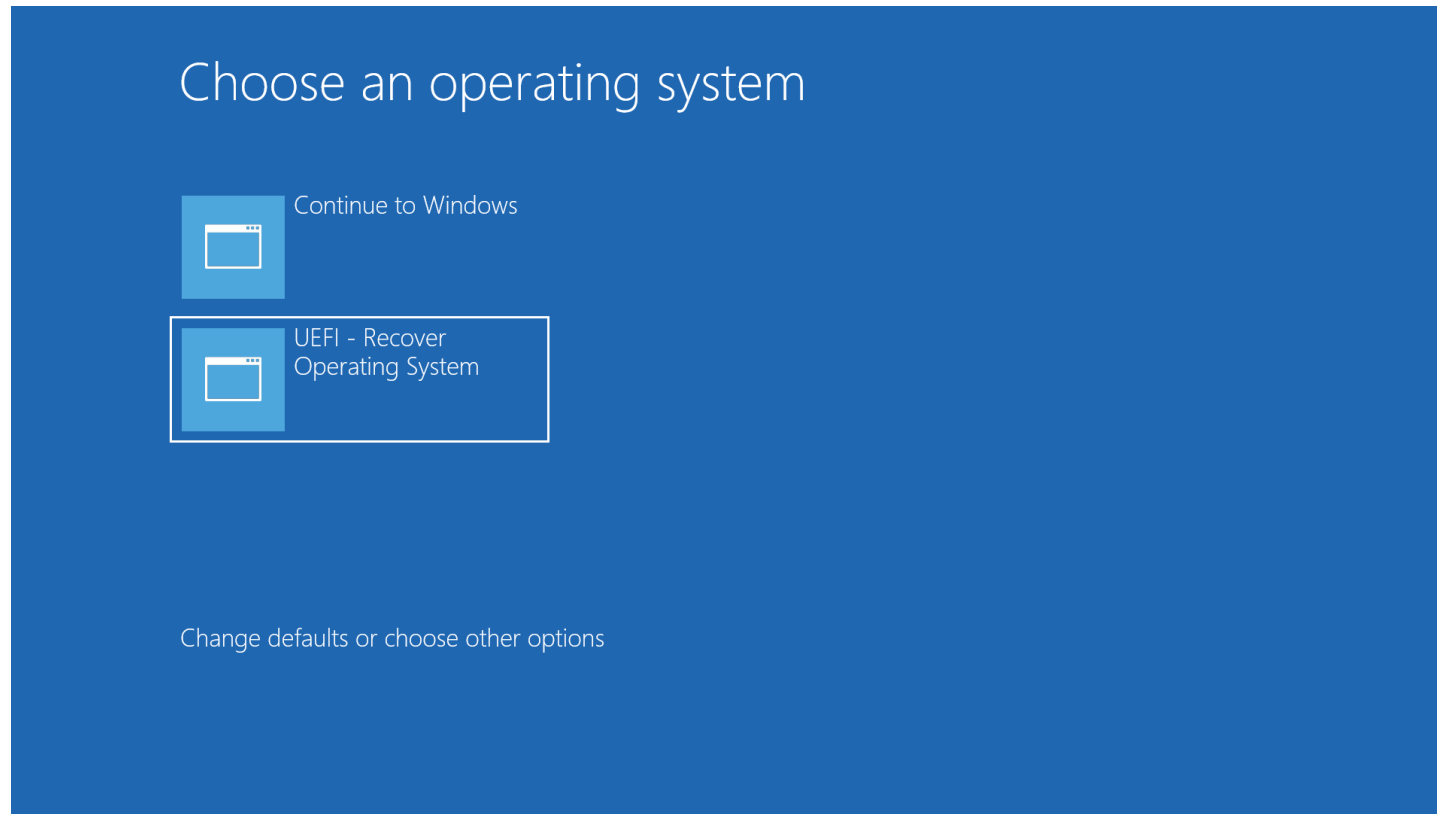

4. The following User Interface (UI) will be presented.

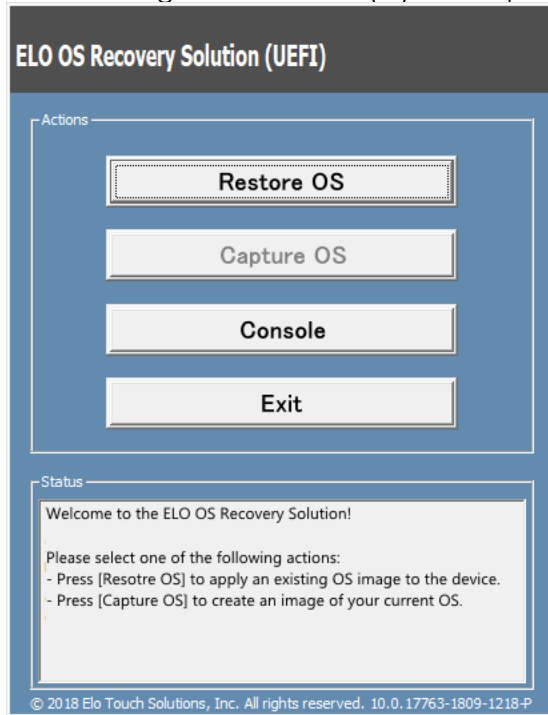

5. Select **Restore OS**. The system will test your hardware automatically. Once the process completes, click **Start** button to perform the system recovery function.

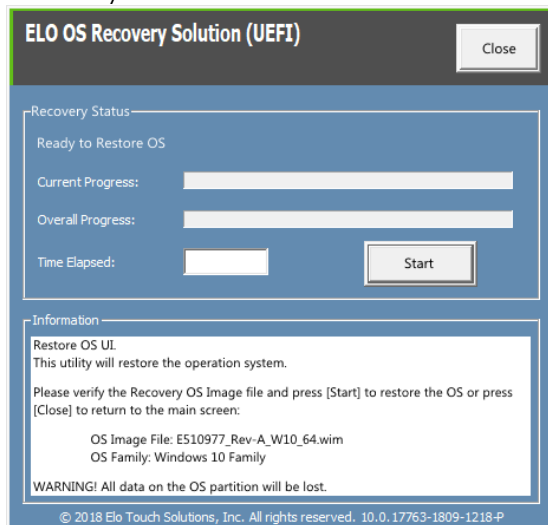

6. The following process will reformat the primary hard drive. **Please back up your data before performing the recovery process.**

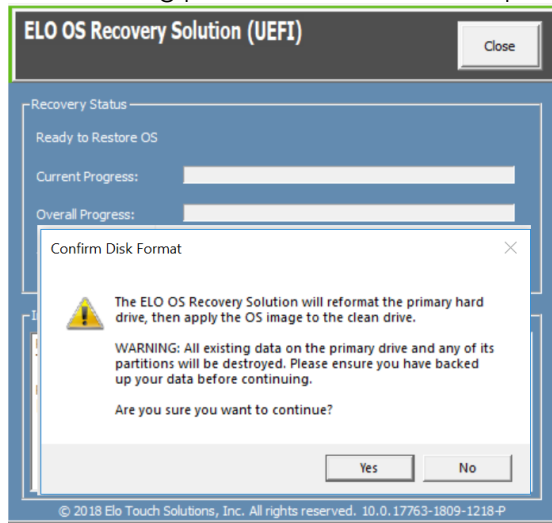

7. Once completed, click the **Close** button. The system will return to the main menu of the Elo Recovery Solution. Then click the **Exit** button to restart your system.

**NOTE: All data is deleted during the recovery process. The user must back up files when necessary. Elo Touch Solutions does not accept liability for lost data or software.**

**NOTE: The end user must adhere to Microsoft's Licensing Agreement.**

## Reconfigure COM Port Order

In some cases, Windows may re-arrange the order of EloPOS COM ports due to OS recovery, a significant hardware change...etc. When this occurs, Elo provides a COM port rename tool located in "C:\EloTouchSolutions\Peripherals\RS232\COMPortResetUtility\". Please ensure you execute it as Administrator. The system will reboot and two COM ports will be set to COM1 and COM2.

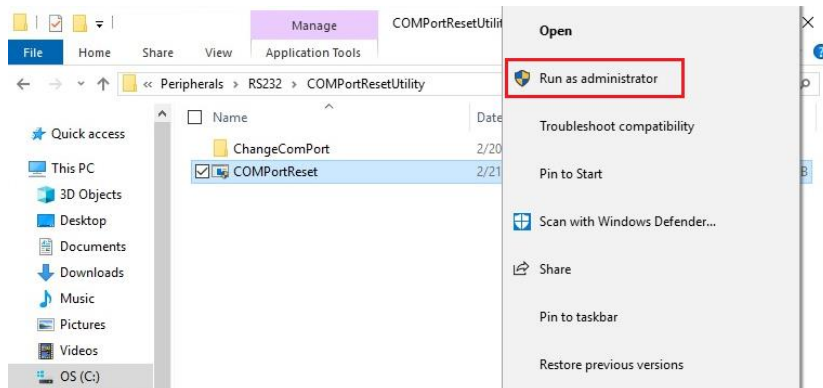

# Section 4: Options and Upgrades

## Adding Optional Upgrades

Elo has qualified the following to work seamlessly with your unit. The complete installation and setup instructions are provided with the field- installable kits. Please see your Elo authorized distributor or value-added partner for pricing.

- 256GB 2.5" SATA SSD (E061525)
- 4GB DDR4 Memory SO-DIMM (E275416)
- 8GB DDR4 Memory SO-DIMM (E275635)

## Optional Peripherals KITS

The following optional accessories and spare parts are available for purchase from Elo Touch Solutions. Shown in parenthesis is the Elo orderable part number.

- **Biometric Fingerprint Reader (E001001)**
  - Fingerprint reader with USB interface for all EloPOS configurations
- **Magnetic Stripe Reader (E001002)**
  - MSR with USB interface for all EloPOS configurations
- **Rear-Facing Customer Display Kit (E001003)**
  - The vacuum fluorescent display (VFD) with USB interface for all EloPOS configurations
- **2D Scanner Barcode Scanner (E926356)**
  - 2D Barcode Scanner with USB interface for all EloPOS configurations
- **10" LCD Customer Display (10 touch – E045337)**
  - This requires display mount kit – E835969
- **10" LCD Customer Display (no touch – E138394)**
  - This requires display mount kit – E835969
- **Dallas Key (E055348)**
  - The Dallas Key is designed for simple log in or log out by the person with a mating key.
- **13" LCD Customer Display (10 touch – E683595)**
  - This requires display mount kit – E835969
- **EMV Cradle eDynamo Kit (E375343)**
  - The EMV Cradle Kit is designed for a MagTek eDynamo device for all EloPOS configurations.

- **EMV Cradle Ingenico RP457 KIT (E710930)**

- The EMV Cradle Kit is designed for an Ingenico RP457c device for all EloPOS configurations.

**NOTE: When a 2<sup>nd</sup> display monitor is installed but it does not have a USB-C port, you will need to purchase a USB-C to HDMI cable in order to connect to EloPOS system. Elo has qualified USB-C to HDMI adapters listed in below. Please go your local retailers to purchase these cables.**

- **Uni USB-C to HDMI Cable (4K@60Hz) – 3ft/6ft**
- **Cable Creation USB-C to HDMI Cable (4K@60Hz) – 6ft**
- **Cable Matters USB-C to HDMI Cable (4K@60Hz) – 6ft**
- **UGREEN USB-C to HDMI Cable (4K@60Hz) – 5ft**

**In addition, please enter BIOS menu and select Advanced → USB Configuration → USB Type-C Setting. Then, change the setting to DP 4 Lanes + USB 2.0 to make USB-C to HDMI adapter work.**



# Section 5: Technical Support

If you are experiencing trouble with your touchscreen computer, refer to the following suggestions. If the problem persists, please contact your local dealer or Elo Customer Service. Worldwide technical support phone numbers are available on the last page of this user manual.

## Solutions to Common Problems

Problem	Suggested Troubleshooting
No Power (The EloPOS unit won't power up)	<ol style="list-style-type: none"><li>1. Check that the AC/DC power adaptor is properly connected</li><li>2. Verify the AC power source is functioning</li><li>3. Make sure the power button is not broken</li></ol>
No Display (Display is black)	<ol style="list-style-type: none"><li>1. If the Power Status LED is orange/red, the unit may be in SLEEP/HIBERNATE mode. Press the power button to see if the display comes back.</li><li>2. Check the internal cable connections and look for missing or damaged electrical components.</li></ol>
No Bootable Device Found	<ol style="list-style-type: none"><li>1. Confirm the product has loaded the OS.</li><li>2. Storage device damage - Try to swap with another new blank drive</li></ol>
Abnormal/No Touch Function	<ol style="list-style-type: none"><li>1. Check the touch device presents in Windows Device Manager</li><li>2. Power off the system and power on again</li><li>3. Make sure there is not damage to the touch screen</li></ol>

## Technical Assistance

### Technical Specifications

Visit [www.elotouch.com/products](http://www.elotouch.com/products)  
for technical specifications for this device

### Support

Visit <http://support.elotouch.com/TechnicalSupport/> for technical support

See this user manual's last page for worldwide technical support phone numbers.



# Section 6: Safety & Maintenance

## Safety

- To avoid risk of electric shock, follow all safety notices and do not disassemble the touch computer. They are not user-serviceable.
- Do not block or insert anything inside the ventilation slots.
- The Elo EloPOS is equipped with an AC/DC power adaptor. Do not use a damaged AC/DC power adaptor. Use only the AC/DC power adaptor supplied by Elo for the EloPOS. Use of an unauthorized AC/DC power adaptor may void your warranty.
- Ensure that the system is maintained and runs within the specified environmental conditions listed below.
- Be sure to disconnect the power source before disassemble the equipment. The enclosure must be completely assembled while restoring the power input. Wait one-half hour after switching off before handling parts.

### Environmental conditions for operating and storage

#### Temperature:

Operating	0°C to 35°C
Storage	-30°C to 60°C

#### Humidity (non-condensing):

Operating	20% to 80%
Storage	5% to 95%

#### Altitude:

Operating	0 to 3,048 m
Storage	0 to 12,192 m

#### Power ratings

**Any EloPOS models:** 24 volts, 7.5 Amps max

## EloPOS Power Adaptor Support Notice

The following notice will help on the application when you use the Power USB function of your Elo EloPOS.

- Do not exceed a total of 180 watts. Take the wattage below and add the Elo Peripherals or your other devices and check that you are under 180 watts. If you need help with the power requirements for your application, please contact Elo support to help you with the set up and calculations.

	E2	E3	E5
Max Power Consumption (without peripherals)	15" models: 24W	15" models: 65W	15" models: 74W

- The Elo PNs corresponding power adaptor model name list as below table.

Configuration	ELO PN	Part Description
E2/E3/E5	E511572	AIO POWER BRICK, 24VOLT 180W
E2/E3/E5	E511766	AIO POWER BRICK, 24VOLT 180W

## Care and Handling

The following tips will help keep your touch computer functioning at an optimal level:

- Disconnect the AC power cable before cleaning.
- To clean the unit (except touchscreen), use a clean cloth lightly dampened with a mild detergent.
- It is important that your unit remains dry. Do not get liquids on or inside the unit. If liquid does get inside, turn the unit off and have a qualified service technician check it before you power it on again.
- Do not wipe the screen with a cloth or sponge that could scratch the surface.
- To clean the touchscreen, use window or glass cleaner applied to a clean cloth or sponge. Never apply the cleaner directly to the touchscreen. Do not use alcohol (methyl, ethyl or isopropyl), thinner, benzene, or other abrasive cleaners.
- Ensure the environmental temperature and humidity are maintained within specification and do not block ventilation slots.
- Touch computers are not designed for outdoors.

## Waste Electrical & Electronic Equipment Directive (WEEE)



This product should not be disposed of with household waste. It should be deposited at a facility that enables recovery and recycling. Ensure that product is disposed at the end of its useful life according to local laws and regulations. Elo has put in place recycling arrangements in certain parts of the world. For information on how you can access these arrangements, please visit.

<https://www.elotouch.com/e-waste-recycling-program>

## UL Directive

The touch computer has a lithium battery included on the motherboard. There is a risk of explosion if battery is replaced by an incorrect type. Please dispose of used batteries according the region instructions.

## Warning

- It is important that your touch computer remains dry. Do not pour liquid into or onto your touch computer. If your touch computer becomes wet, do not attempt to repair it yourself. Contact Elo Customer Service for instructions.
- Over using the touch computer may damage your eye vision.
- Please take a rest for 10 minutes when you use the system 30 minutes
- Children less than two years old do not look at the screen directly; children over two years old do not look at the screen more than one hour per day

# Section 7: Regulatory Information

## Electrical Safety Information

Compliance is required with respect to the voltage, frequency, and current requirements indicated on the manufacturer's label. Connection to a different power source than those specified herein will likely result in improper operation, damage to the equipment or pose a fire hazard if the limitations are not followed.

There are no operator serviceable parts inside this equipment. There are hazardous voltages generated by this equipment which constitute a safety hazard. Service shall be provided only by a qualified service technician.

Contact a qualified electrician or the manufacturer if there are questions about the installation prior to connecting the equipment to mains power.

## Emissions and Immunity Information

### **Notice to Users in the United States for FCC compliance:**

This device complies with part 15 of the FCC Rules. Operation is subject to the following two conditions:

- (1) This device may not cause harmful interference, and
- (2) this device must accept any interference received, including interference that may cause undesired operation of the device.

Changes or modifications not expressly approved by the party responsible for compliance could void the user's authority to operate the equipment.

NOTE: This equipment has been tested and found to comply with the limits for a Class B digital device, pursuant to part 15 of the FCC Rules. These limits are designed to provide reasonable protection against harmful interference in a residential installation. This equipment generates, uses and can radiate radio frequency energy and, if not installed and used in accordance with the instructions, may cause harmful interference to radio communications. However, there is no guarantee that interference will not occur in a particular installation. If this equipment does cause harmful interference to radio or television reception, which can be determined by turning the equipment off and on, the user is encouraged to try to correct the interference by one or more of the following measures:

- Reorient or relocate the receiving antenna.

- Increase the separation between the equipment and receiver.
- Connect the equipment into an outlet on a circuit different from that to which the receiver is connected.
- Consult the dealer or an experienced radio/TV technician for help.

This equipment should be installed and operated to ensure a minimum of 20 cm spacing to any person.

### **Notice to Users in Canada for IC compliance:**

This equipment complies with the Class A limits for radio noise emissions from digital apparatus as established by the Radio Interference Regulations of Industrial Canada.

CAN ICES3 (B)/NMB3(B)

This device contains licence-exempt transmitter(s)/receiver(s) that comply with Innovation, Science and Economic Development Canada's licence-exempt RSS(s). Operation is subject to the following two conditions:

- (1) This device may not cause interference.
- (2) This device must accept any interference, including interference that may cause undesired operation of the device.

L'émetteur/récepteur exempt de licence contenu dans le présent appareil est conforme aux CNR d'Innovation, Sciences et Développement économique Canada applicables aux appareils radio exempts de licence. L'exploitation est autorisée aux deux conditions suivantes :

- (1) L'appareil ne doit pas produire de brouillage;
- (2) L'appareil doit accepter tout brouillage radioélectrique subi, même si le brouillage est susceptible d'en compromettre le fonctionnement.

### **Notice to Users in the European Union:**

Use only the provided power cords and interconnecting cabling provided with the equipment. Substitution of provided cords and cabling may compromise electrical safety or CE Mark Certification for emissions or immunity as required by the following standards:  
This Information Technology Equipment (ITE) is required to have a CE Mark on the Manufacturer's label which means that the equipment has been tested to the following Directives and Standards: This equipment has been tested to the requirements for the CE Mark as required by EMC Directive 2014/30/

EU as indicated in European Standard EN 55032 Class B and the Low Voltage Directive 2014/35/EU as indicated in European Standard EN 60950-1.

## General Information to all Users:

This equipment generates, uses and can radiate radio frequency energy. If not installed and used according to this manual the equipment may cause interference with radio and television communications. There is, however, no guarantee that interference will not occur in any particular installation due to site-specific factors.

1. In order to meet emission and immunity requirements, the user must observe the following:
  - a. Use only the provided I/O cables to connect this digital device with any computer.
  - b. To ensure compliance, use only the provided manufacturer's approved line cord.
  - c. The user is cautioned that changes or modifications to the equipment not expressly approved by the party responsible for compliance could void the user's authority to operate the equipment.
  
2. If this equipment appears to cause interference with radio or television reception, or any other device:
  - a. Verify as an emission source by turning the equipment off and on. If you determine that this equipment is causing the interference, try to correct the interference by using one or more of the following measures:
    - i. Move the digital device away from the affected receiver.
    - ii. Reposition (turn) the digital device with respect to the affected receiver.
    - iii. Reorient the affected receiver's antenna.
    - iv. Plug the digital device into a different AC outlet so the digital device and the receiver are on different branch circuits.
    - v. Disconnect and remove any I/O cables that the digital device does not use. (Unterminated I/O cables are a potential source of high RF emission levels.)
    - vi. Plug the digital device into only a grounded outlet receptacle. Do not use AC adapter plugs. (Removing or cutting the line cord ground may increase RF emission levels and may also present a lethal shock hazard to the user.)

If you need additional help, consult your dealer, manufacturer, or an experienced radio or television technician.

## EloPOS Classification of Certificate

Series	Configuration	Classification	Documentation
15" Series	E2/E3/E5	Class B	MD600091 DECLARATIONS OF CONFORMITY, EPS15XX SERIES

この装置は、クラスB機器です。この装置は、住宅環境で使用することを目的としていますが、この装置がラジオやテレビジョン受信機に近接して使用されると、受信障害を引き起こすことがあります。

取扱説明書に従って正しい取り扱いをして下さい。

VCCI - B

## Radio Equipment Directive

Elo hereby declares that the radio equipment type, Elo POS, is in compliance with Directive 2014/53/EU. The full text of the EU Declaration of Conformity is available at the following internet address: [www.elotouch.com](http://www.elotouch.com)

This device is designed and intended for indoor use only when operating in the 5150 to 5350 MHz frequency range.

	AT	BE	BG	HR	CY	CZ	DK
	EE	FI	FR	DE	EL	HU	IE
	IT	LV	LT	LU	MT	NL	PL
	PT	RO	SK	SI	ES	SE	UK

Operation frequency and radio-frequency power are listed as below:

o WLAN 802.11a/b/g/n/ac 2400GHz ≤ 20 dBm EIRP

5150 – 5250GHz ≤ 23 dBm EIRP

o Bluetooth 2.4GHz ≤ 9.5 dBm

## ECC/DEC/ (04)08:

The use of the frequency band 5 150-5 350 MHz is restricted to indoor operation because of the protection requirements of satellite services

## EC R&TTE Directive

**EU Directive 2014/53/EU** of the European Parliament and of the Council of 16 April 2014 on the harmonization of the laws of the Member States relating to the making available on the market of radio equipment and repealing Directive 1999/5/EC Text with EEA relevance.



Identification mark

The relevant technical documentation is held at: Elo Touch Solutions, Inc.  
670 N. McCarthy Boulevard Suite 100  
Milpitas, CA 95035  
USA.

#### **USA**

FCC ID: PD99260NG

#### **Canada**

IC ID: 1000M-9260NG

#### **Japan**

RF 003-170125

TEL D170079003

電波法により5GHz帯は屋内使用に限ります。

#### **Argentina**

**CNC:** C-20821

#### **Brazil**

Anatel: 05831-17-04423

*Este equipamento não tem direito à proteção contra interferência prejudicial e não pode causar interferência em sistemas devidamente autorizados.*

#### **Mexico**

RCPIN9517-1585

Información México La operación de este equipo está sujeta a las siguientes dos condiciones:

- 1) es posible que este equipo o dispositivo no cause interferencia perjudicial y
- 2) este equipo debe aceptar cualquier interferencia, incluyendo la que pueda causar su operación no deseada.

#### **RF Exposure Information (SAR)**

This device has been tested and meets applicable limits for Radio Frequency (RF) exposure. Specific Absorption Rate (SAR) refers to the rate at which the body absorbs RF energy. Tests for SAR are conducted using standard operating positions with the device transmitting at its highest certified power level in all tested frequency bands. This device was tested with a separation distance of **20cm**. Always keep this device away from your body to ensure exposure levels remain at or below the as-tested levels.



## FCC Declaration of Conformity

Per FCC 47 CFR FCC Part15 subpart B Section 2.1077(a)  
In accordance with FCC Rules and Regulations

**Model Number:** EPS15EX (X can be 0-9)  
**Equipment Category:** Information Technology and Telecommunications Equipment  
**Equipment Class:** Commercial and Light Industrial  
**Product Name:** Touch All in one Computer  
**Manufacturer:** Elo Touch Solutions, Inc.  
670 N. McCarthy Blvd.  
Suite 100  
Milpitas, CA 95035  
[www.elotouch.com](http://www.elotouch.com)

**Trademark:**

The logo for Elo, featuring the word "elo" in a bold, lowercase, sans-serif font. The letter "e" has a horizontal bar extending to the left, resembling a stylized "ē".

**Declaration:**

This device complies with Part 15 of the FCC Rules. Operation is subject to the following two conditions:

- (1) This device may not cause harmful interference, and
- (2) this device must accept any interference received, including interference that may cause undesired operation

A handwritten signature in blue ink, appearing to read "Kevin Huang", written over a horizontal line.

Kevin Huang  
Director, Systems Engineering  
Elo Touch Solutions, Inc.

## Agency Certifications

The following certifications and marks have been issued or declared for this system:

- United State FCC, UL , Energy Star®
- Canada IC
- Europe CE, CB, TUV
- Australia RCM
- Japan VCCI
- Argentina S-Mark
- Brazil, ANATEL
- Mexico NOM
- China CCC, SRRC

## Explanation of Markings

- In accordance with the SJ/T11364-2006 requirement, the electronic information products are marked with the following pollution control logo. The Environment-Friendly Use Period for this product is 10 years. The product will not leak or mutate under normal operating conditions listed below, so that the use of this electronic information product will not result in any severe environmental pollution, any bodily injury, or damage to any assets.

Operating Temperature: 0-35 / Humidity: 20%-80% (non-condensing).  
Storage Temperature: -20~60 / umidity:10%~95% (non-condensing).



- It is encouraged and recommended that this product be recycled and reused according to local laws. The product should not be thrown away casually.

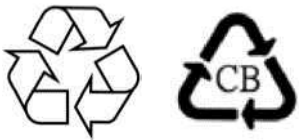

## China RoHS

In accordance to Chinese law (Management Methods for the Restriction of the Use of Hazardous Substances in Electrical and Electronic Products), the section below lists out the name and amount of the toxic and/or hazardous materials that this product may contain.

Component Name	Toxic or Hazardous Substances and Elements					
	Lead (Pb)	Mercury (Hg)	Cadmium(Cd)	Hexavalent Chromium (Cr6+)	Polybrominated Biphenyls (PBB)	Polybrominated Diphenyl Ethers (PBDE)
Plastic Parts	○	○	○	○	○	○
Metal Parts	X	○	○	○	○	○
Wire and Cable	X	○	○	○	○	○
LCD Panel	X	○	○	○	○	○
Touch Screen Panel	X	○	○	○	○	○
PCBA	X	○	○	○	○	○

## 中国 RoHS (China RoHS)

根据中国法律《电器电子产品有害物质限制使用管理办法》，以下部分列出了产品中可能包含的有害物质的名称和含量。

中国电子电气产品环境信息

触控一体机	有害物质					
	铅 (Pb)	水 (Hg)	镉 (Cd)	六价铬 (Cr(VI))	多溴联苯 (PBB)	多溴二苯 (PBDE)
电缆组件	X	○	○	○	○	○
玻璃外罩	X	○	○	○	○	○
液晶面板	X	○	○	○	○	○
金属框架	X	○	○	○	○	○
塑胶盖	○	○	○	○	○	○
印制线路板	X	○	○	○	○	○

本表格依据 SJ/T 11364 的规定编制。  
○：表示该有害物质在该部件所有均质材料中的含量均在 GB/T 26572 规定的限量要求以下。  
X：表示该有害物质至少在该部件的某一均质材料中的含量超出 GB/T 26572 规定的限量要求。

### 标志说明

根据 SJ/T11364 的要求，电子信息产品标有以下污染控制标识。此产品在 10 年内不会对环境产生影响。



## Section 8: Warranty Information

For warranty information, go to <http://support.elotouch.com/warranty/>



## [www.elotouch.com](http://www.elotouch.com)

Visit our website for the latest

Product Information

Specifications

Upcoming Events

Press Releases

Software Drivers

Touch Monitor Newsletter

To find out more about our extensive range of Elo touch solutions, go to [www.elotouch.com](http://www.elotouch.com), or call the office nearest you.

---

### North America

Tel +1 408 597 8000

Fax +1 408 597 8001

[elosales.na@elotouch.com](mailto:elosales.na@elotouch.com)

### Europe

Tel +32 (0)16 70 45 00

Fax +32 (0)16 70 45 49

[elosales@elotouch.com](mailto:elosales@elotouch.com)

### Asia-Pacific

Tel +86 (21) 3329 1385

Fax +86 (21) 3329 1400

[www.elotouch.com.cn](http://www.elotouch.com.cn)

### Latin America

Tel +52 55 2281-6958

[elosales.latam@elotouch.com](mailto:elosales.latam@elotouch.com)



© 2019 Elo Touch Solutions, Inc. All rights reserved.