

DIMENSIONAL DRAWING:EPS BACKPACK

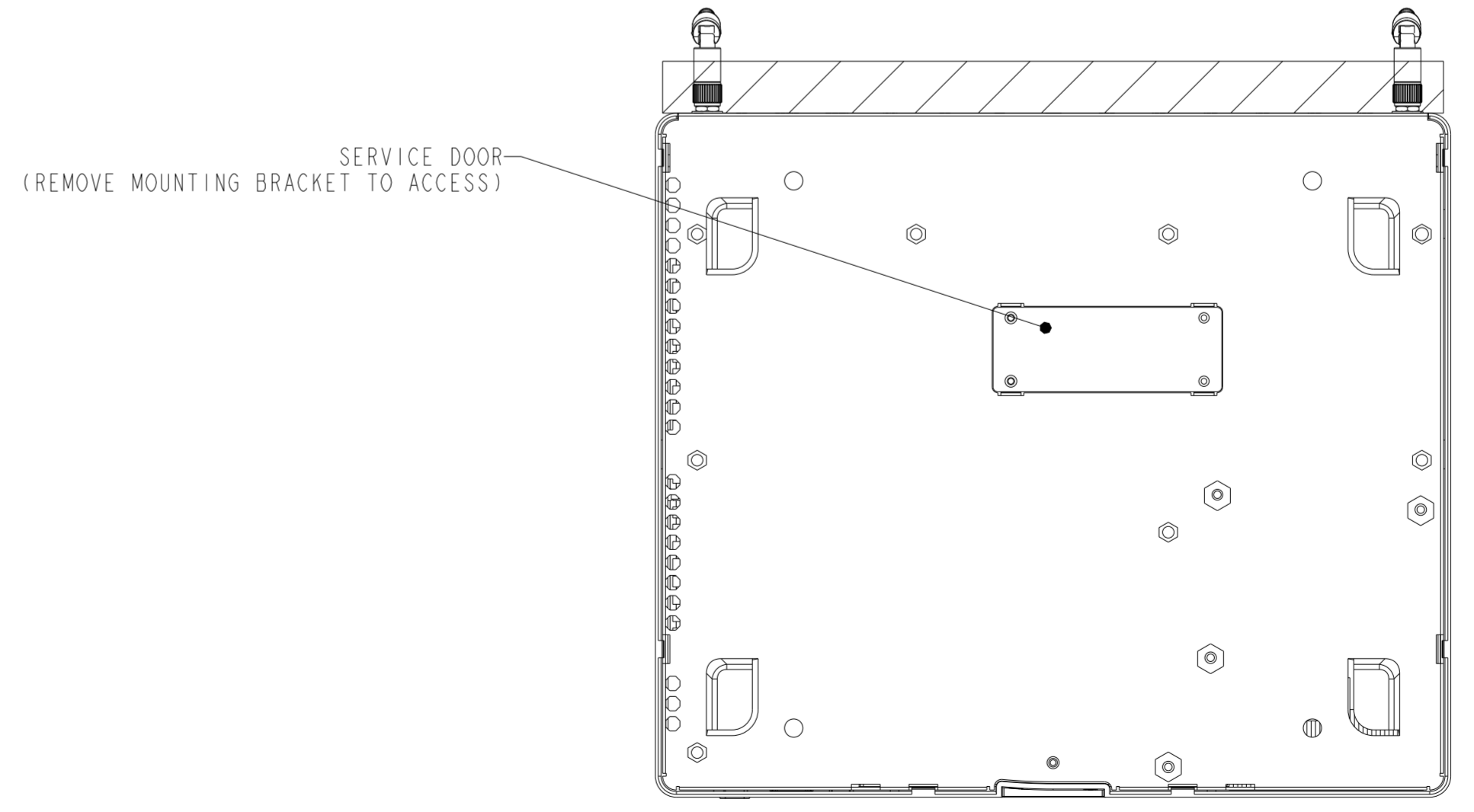
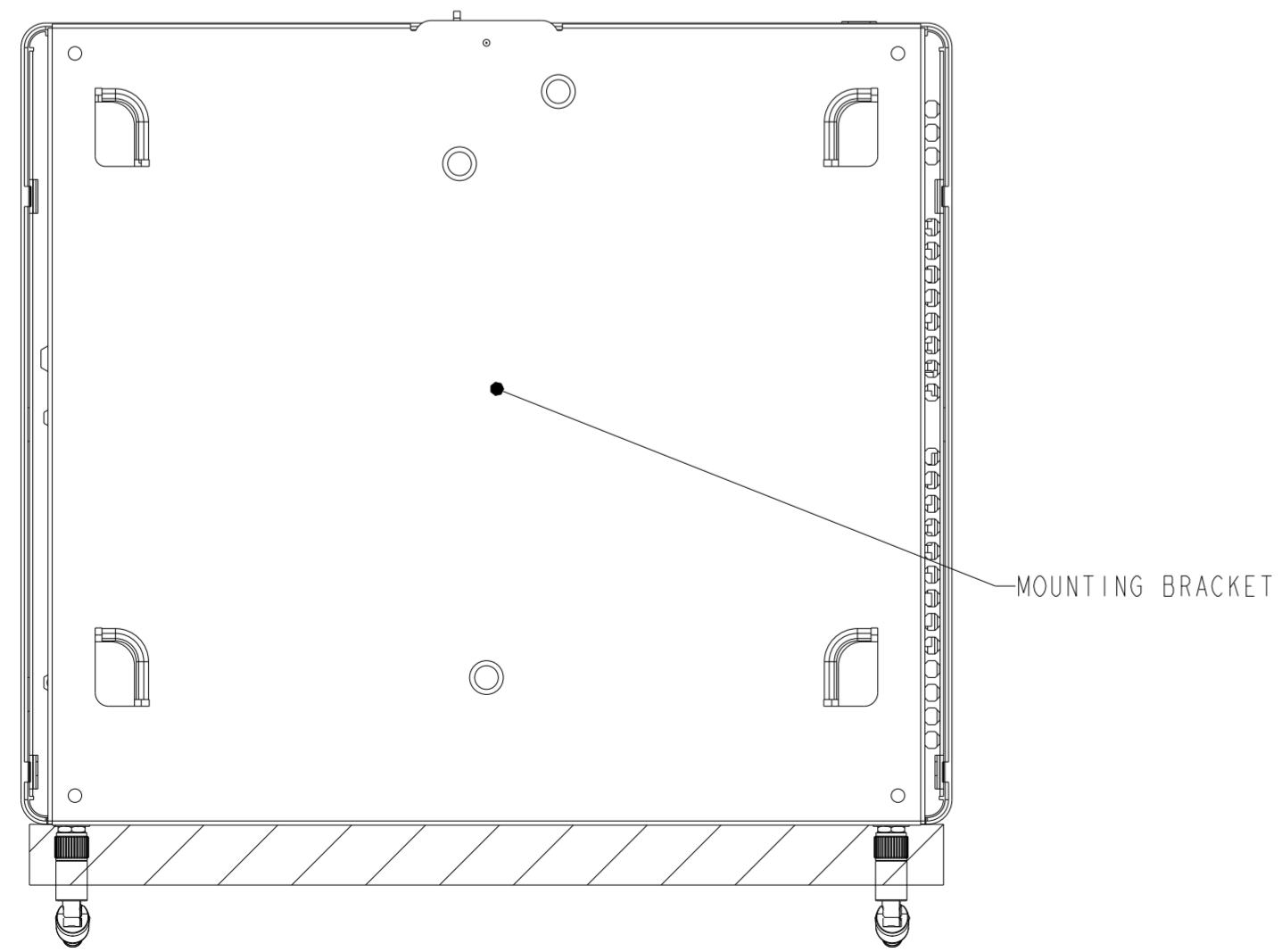
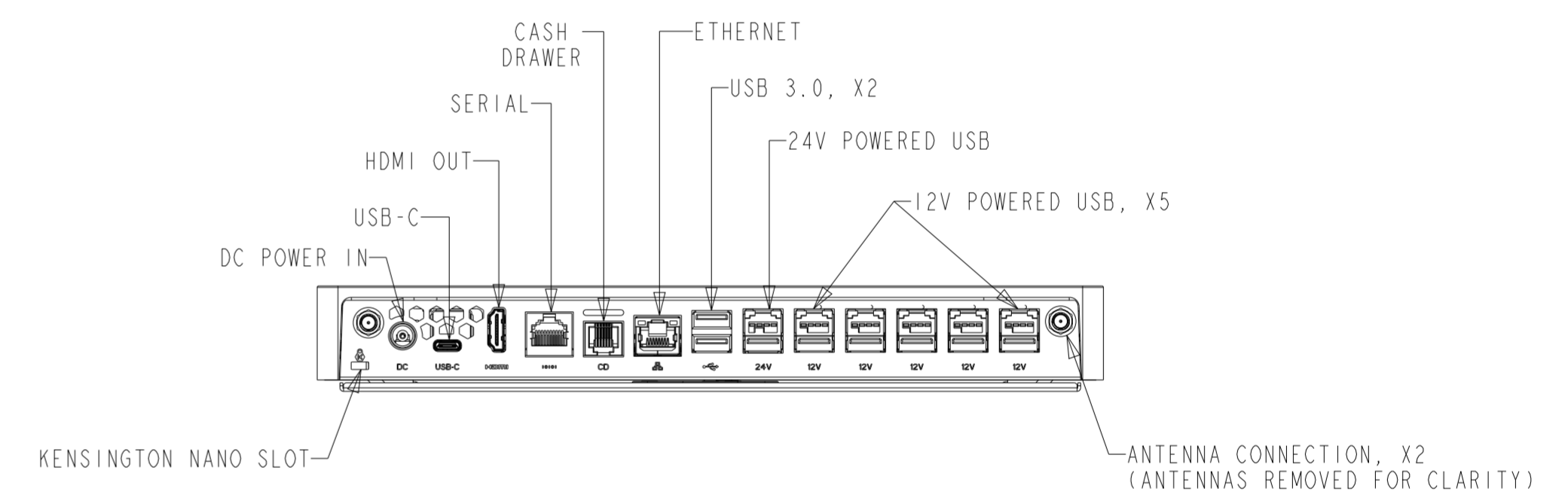
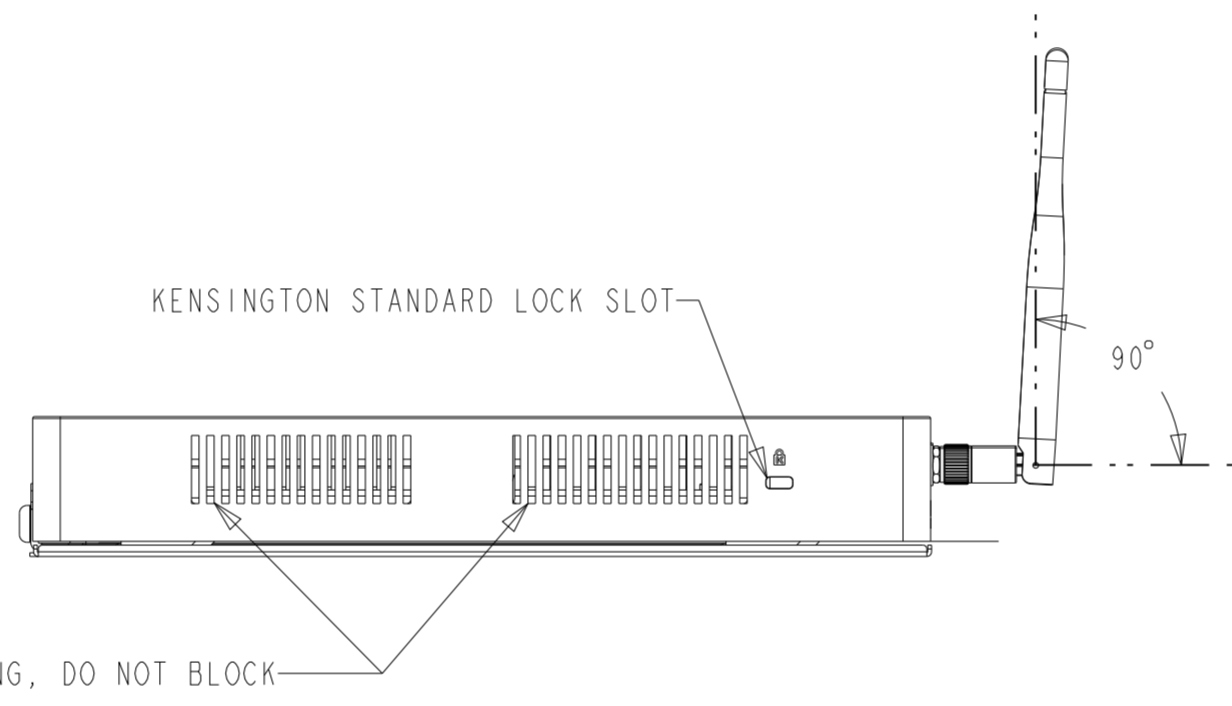
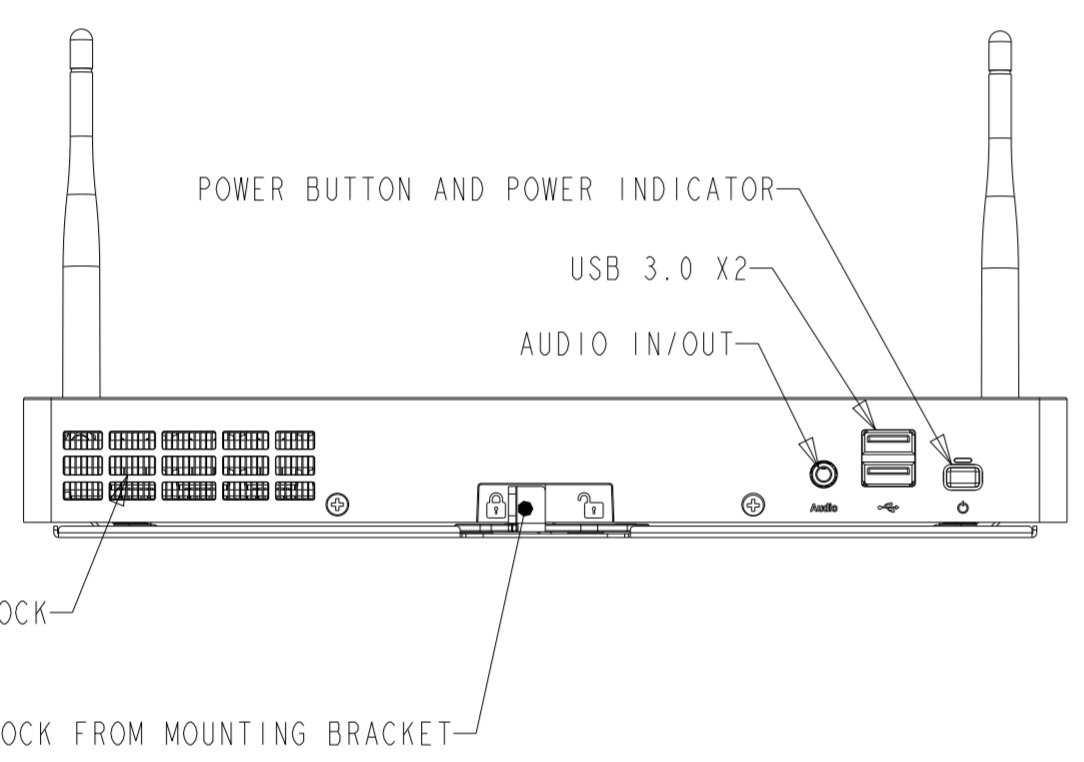
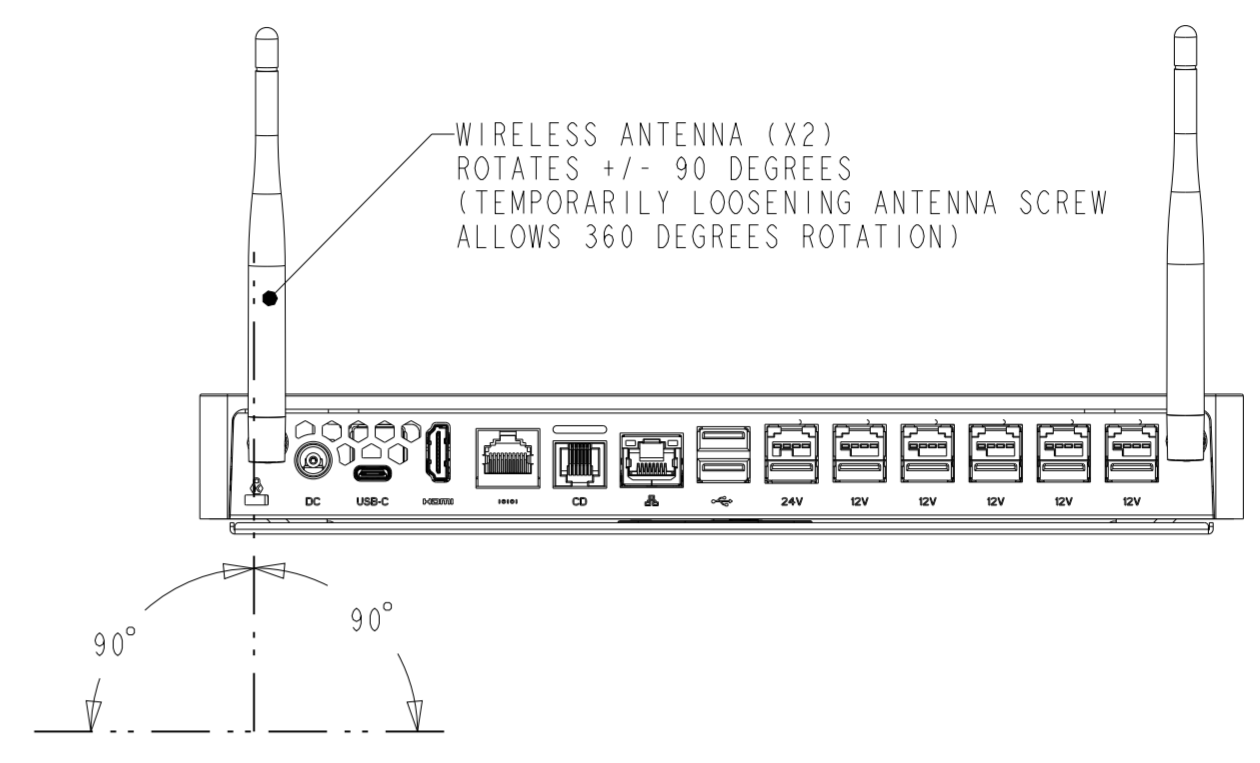
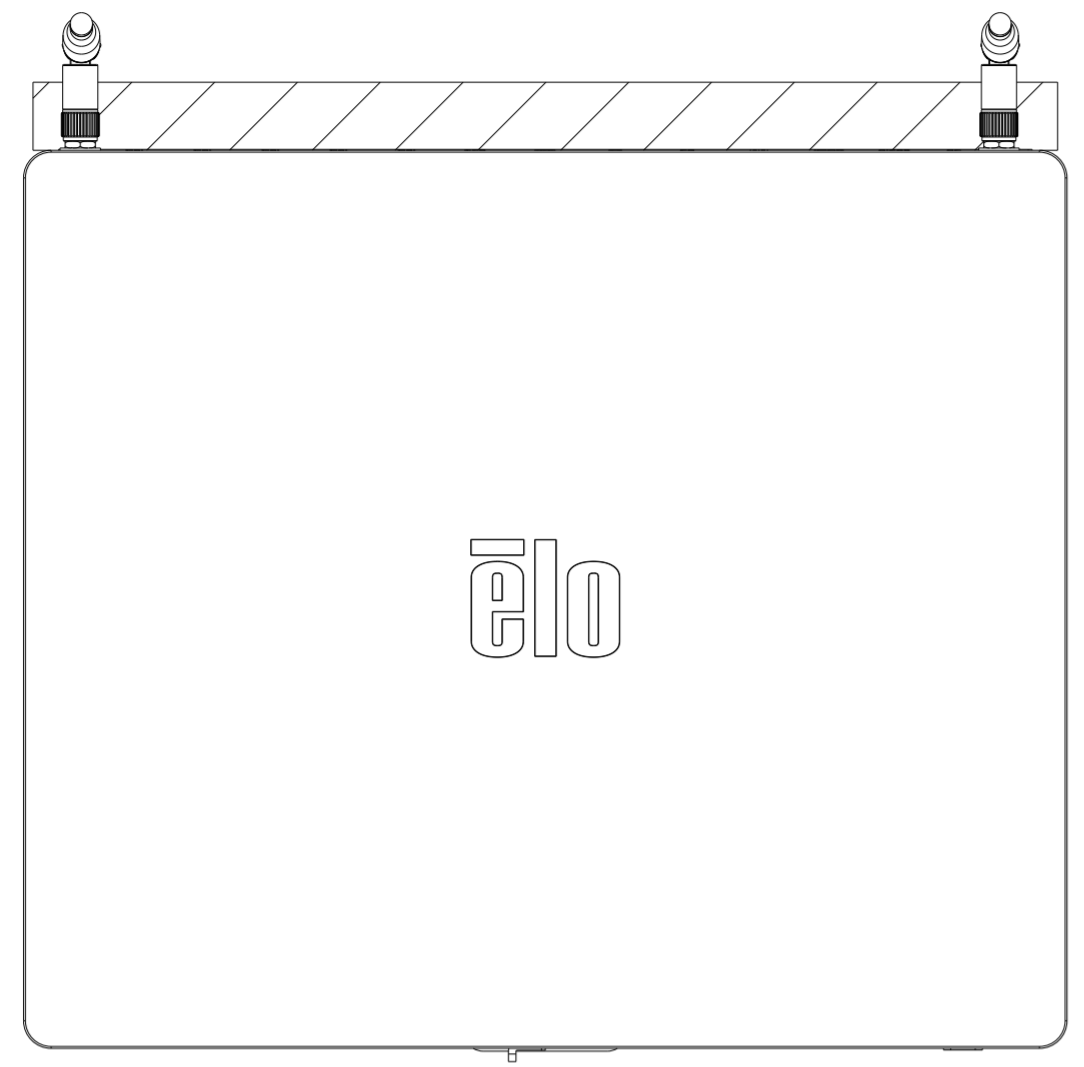

INSTALLATION INSTRUCTIONS:

1. SECURE MOUNTING BRACKET BY INSTALLING 4X M3 SCREWS APPROPRIATE FOR MOUNTING SURFACE.
2. MOVE LATCH TO THE RIGHT SIDE TO UNLOCK IT.
3. LOWER EPS BACKPACK DOWN ONTO THE MOUNTING BRACKET SO IT SITS ABOUT 18MM (0.7") BACK FROM THE LATCH.
4. SLIDE THE BACKPACK FORWARD ABOUT 25MM (0.7") ENSURING ALL FOUR HOOKS ENGAGE.
5. SLIDE THE LATCH LEFT TO LOCK THE BACKPACK IN PLACE.

REMOVAL IS REVERSE OF INSTALLATION

